

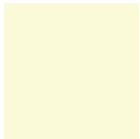











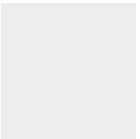

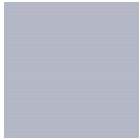



Nicolle Metal Chair

The Nicolle Metal Chair is part of the Nicolle series, manufactured in France since 1933. The steel chairs and bar stools from this have an elegant, industrial style. Unique design features include the swan neck and whale tail shaped backrest. Extremely comfortable, the back rest is in the perfect ergonomic spot and flexes slightly left and right as you move your back. Remove the back, and voilà, it becomes a stool.



- Contract
- Indoor / Covered Outdoor

MATERIAL	Stamped Metal with Polyethylene Chair Feet					
FINISH	Powder Coating - AXALTA® POLYESTER AE GLOSS or Any RAL Color (no charge for 6+ pieces)					
						
	RAL 5024 Textured Pastel Blue	RAL 9010 Textured Pure White	RAL 5017 Textured Traffic Blue	RAL 2004 Glossy Pure Orange	RAL 3020 Glossy Traffic Red	RAL 9016 Glossy White
						
	Matte Dark Steel	Steel Grey	RAL 1007 Glossy Daffodil Yellow	RAL 9005 Matte Black	RAL 3011 Glossy Brown Red	RAL 6003 Matte Olive Green
ADD ON	Leather Seat Pad					
						
	Black	Dark Brown	Red	Hazelnut Ostrich	Stone	Wildcat
						
	Natural	Gypsy Blue				

DIMENSIONS

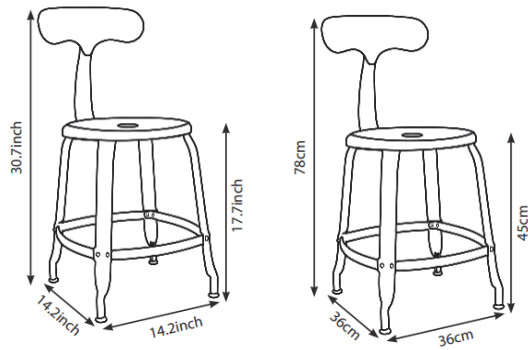

Inches

Centimeters

Model CH 60